

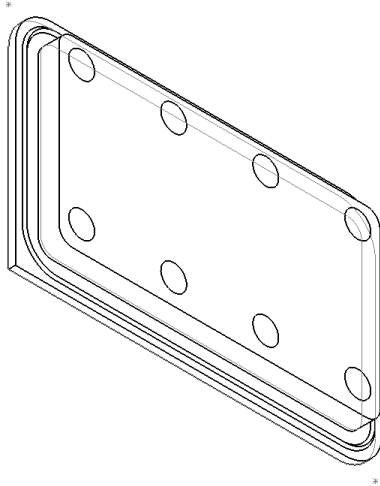

# Coining Technologies

INCORPORATED

## Open Tool Catalog Dual In-Line Platforms Coined Headers



Phone +1.973.253.0500 • Fax +1.973.253.9611 • e-mail [sales@coining.com](mailto:sales@coining.com)  
[www.coining.com](http://www.coining.com)

Rev. A-113007

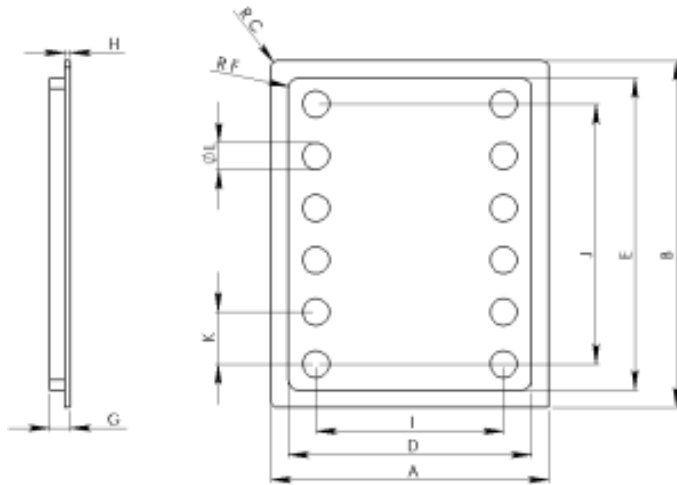

400 Kuller Road  
 Clifton, NJ 07011  
 Phone: 973.253.0500  
 Fax: 973.253.9611  
 Web: www.coining.com  
 E-mail: sales@coining.com

## DL • Dual In-Line Platforms • Coined Headers

	A	B	C	D	E	F	G	H	I	J	K	L
CTI Part#	Overall Width	Overall Length	OD Radius	Body Width	Body Length	Body Radius	OAH	Flange Thickness	Hole Grid Width	Hole Grid Length	Hole Pitch	Hole Dia
DL-292-01B	0.170	0.561		0.110	0.501		0.060	0.015	0.273			0.068
DL-300-02B	0.300	1.598	0.150	1.290	0.998		0.080	0.060				
DL-328-02E	0.328	1.068	0.060	0.318	1.056	0.050	0.055	0.025	0.795		0.200	0.060
DL-528	0.331	1.085	0.031	0.271	1.025	0.016	0.055	0.030	ODD		ODD	0.050
DL-001-04B	0.335	0.614	0.087	0.240	0.520	0.059	0.060	0.030	0.400		0.100	0.063
DL-601	0.358	0.550	0.144	0.324	0.521	0.127	0.049	0.031	0.177	0.300	0.100	0.059
DL-365-01A	0.365	0.465	0.032	0.310	0.410	0.022	0.049	0.015	0.200	0.300	0.100	0.053
DL-366-01A	0.366	0.366	0.032	0.310	0.310	0.031	0.049	0.015	0.200	0.200	0.100	0.047
DL-367-01A	0.366	0.366	0.032	0.310	0.310	0.031	0.049	0.015	0.200	0.200	0.100	0.047
DL-790-01A	0.380	0.790	0.045	0.352	0.762	0.030	0.065	0.025	0.200	0.600	0.200	0.089
DL-107-04A	0.409	0.409	0.050	0.323	0.323	0.019	0.031	0.020			N/A	0.138
DL-535	0.418	0.458	0.032	0.363	0.403	0.030	0.049	0.012	0.200	0.300	0.100	0.080
DL-535-01A	0.418	0.458	0.030	0.363	0.402	0.030	0.050	0.009	0.200	0.300	0.100	0.080
DL-535-02A	0.418	0.458	0.030	0.363	0.402	0.030	0.050	0.016	0.200	0.300	0.100	0.080
DL-551	0.449	0.921	0.046	0.397	0.869	0.030	0.060	0.015	0.300	0.700	0.100	0.056
DL-206	0.460	0.760	0.080	0.385	0.685	0.040	0.060	0.015	0.300	0.600	0.100	0.056
DL-564-02A	0.474	0.874	0.080	0.400	0.800	0.030	0.060	0.015	0.300	0.700	0.100	0.056
DL-564-A	0.474	0.874	0.080	0.400	0.800	0.035	0.060	0.015	0.400	0.700	0.100	0.056
DL-564-B	0.474	0.874	ANGLE	0.400	0.800	0.035	0.060	0.015	0.400	0.700	0.100	0.056
DL-522-01B	0.477	0.752	0.025	0.397	0.698	0.030	0.060	0.015	0.300	0.600	0.200	0.056
DL-522	0.480	0.750	0.025	0.397	0.698	0.030	0.060	0.015	0.300	0.600	0.100	0.056
DL-206-02A	0.480	0.760	0.080	0.386	0.685	0.036	0.060		0.300	0.600	0.100	0.056
DL-131	0.484	0.974	0.046	0.474	0.964	0.016	0.093	0.033	0.200	0.600	0.200	0.125
DL-131-05B	0.484	0.974	0.046				0.093		0.200	0.800	0.200	0.250
DL-131-04B	0.484	0.976	0.046				0.093		0.200	0.600	0.200	0.125
DL-412-01B	0.492	0.492	0.087	0.398	0.398	0.039	0.059	0.015	0.300	0.300	0.100	0.056
DL-412-02B	0.492	0.492	0.087	0.398	0.398	0.039	0.059	0.015	0.300	0.300	0.100	0.056
DL-412-03B	0.492	0.492	0.087	0.398	0.398	0.039	0.047	0.015	0.300	0.300	0.100	0.056
DL-288-09A	0.492	1.368	0.080	0.396	1.268	0.035	0.060	0.015	0.300	1.100	0.100	0.056
DL-288-13B	0.492	1.368	0.080	0.396	1.272	0.035	0.060	0.015	0.300	1.100	0.100	0.057

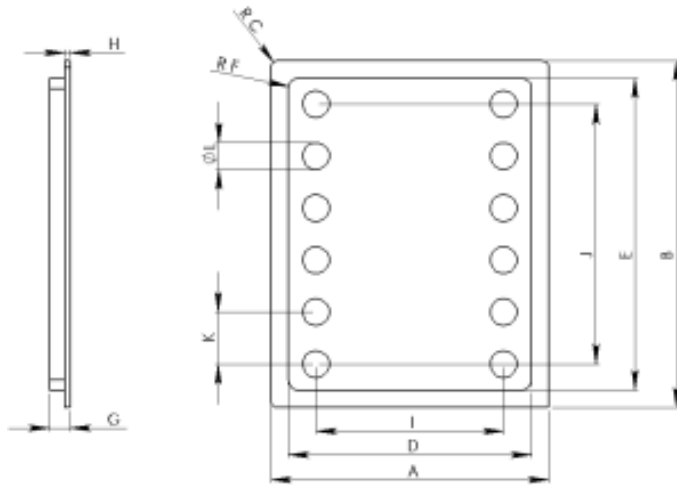

400 Kuller Road  
 Clifton, NJ 07011  
 Phone: 973.253.0500  
 Fax: 973.253.9611  
 Web: www.coining.com  
 E-mail: sales@coining.com

## DL • Dual In-Line Platforms • Coined Headers

	A	B	C	D	E	F	G	H	I	J	K	L
CTI Part#	Overall Width	Overall Length	OD Radius	Body Width	Body Length	Body Radius	OAH	Flange Thickness	Hole Grid Width	Hole Grid Length	Hole Pitch	Hole Dia
DL-288-19A	0.492	1.369	0.080	0.300	1.273	0.035	0.060	0.015	0.300	1.100	0.100	0.057
DL-788	0.493	0.795	0.080	0.398	0.700	0.033	0.060	0.015	0.300	0.600	0.100	0.056
DL-788-02A	0.493	0.795	0.080	0.400	0.701	0.035	0.060	0.015	0.300	0.650	0.050	0.030
DL-788-02B	0.493	0.795	0.080	0.400	0.701	0.035	0.060	0.015	0.300	0.600	0.100	0.056
DL-788-06A	0.493	0.795	0.080	0.400	0.701	0.035	0.060	0.015	0.300	0.600	0.100	0.056
DL-788-07B	0.493	0.795	0.080	0.400	0.701	0.035	0.060	0.015	0.300	0.600	0.100	0.056
DL-288	0.493	1.369	0.080	0.397	1.269	0.035	0.060	0.015	0.300	1.100	0.100	0.056
DL-288-02A	0.493	1.369	0.065	0.300	1.269	0.035	0.060	0.015	0.300	1.100	0.100	0.056
DL-288-13A	0.493	1.369	0.080	0.397	1.259	0.035	0.060	0.015	0.300	1.100	0.100	0.056
DL-288-15B	0.493	1.369	0.080	0.397	0.127	0.035	0.060	0.015	0.300	0.900	0.100	0.056
DL-288-18A	0.493	1.369	0.080	0.397	1.269	0.035	0.060	0.015	0.300	1.100	0.100	0.056
DL-803	0.493	1.369	0.080	0.397	1.269	0.035	0.060	0.015	0.300	1.100	0.100	0.056
DL-113	0.493	1.670	0.080	0.397	1.570	0.035	0.060	0.015	0.300	1.400	0.100	0.056
DL-713-04G	0.493	1.670	0.080	0.397	1.570	0.035	0.060	0.015	0.300	1.400	0.100	0.056
DL-115	0.493	1.970	0.080	0.397	1.870	0.035	0.060	0.015	0.300	1.700	0.100	0.056
DL-115-03A	0.493	1.970	0.080	0.397	1.870	0.035	0.060	0.015	0.300	1.700	0.100	0.056
DL-115-05A	0.493	1.970	0.080	0.397	1.870	0.035	0.060	0.015	0.300	1.700	0.100	0.056
DL-115-05D	0.493	1.970	0.080	0.397	1.870	0.035	0.060	0.015	0.300	1.700	0.100	0.056
DL-115-05G	0.493	1.970	0.080	0.397	1.870	0.035	0.060	0.015	0.300	1.700	0.100	0.056
DL-115-06A	0.493	1.970	0.080	0.397	1.870	0.035	0.060	0.015	0.300	1.700	0.200	0.056
DL-115-04G	0.493	1.970	0.080	0.397	1.870	0.035	0.060	0.015	0.300	1.700	0.100	0.056
DL-117	0.493	2.270	0.080	0.397	2.170	0.035	0.060	0.015	0.300	2.000	0.100	0.056
DL-119	0.493	2.570	0.080	0.397	2.470	0.035	0.060	0.015	0.300	2.300		
DL-119-04G	0.493	2.572	0.080	0.400	2.475	0.035	0.063	0.015	0.300	1.985	0.100	0.056
DL-288-20B	0.494	0.794	0.080	0.400	0.700	0.036	0.059	0.015	0.300	0.600	0.100	0.056
DL-788-17B	0.494	0.794	0.080	0.400	0.700	0.036	0.059	0.015	0.300	0.600	0.100	0.056
DL-788-26B	0.494	0.794	0.080	0.400	0.700	0.036	0.059	0.015	0.300	0.600	0.100	0.056
DL-443-09A	0.494	1.070	0.080	0.420	0.970	0.036	0.059	0.015	0.300	0.800	0.100	0.056
DL-288-14A	0.494	1.370	0.080	0.398	1.270	0.035	0.060	0.015	0.300	1.100	0.100	0.056
DL-288-23A	0.494	1.370	0.080	0.397	1.270	0.031	0.060	0.015	0.300	1.100	0.100	0.057

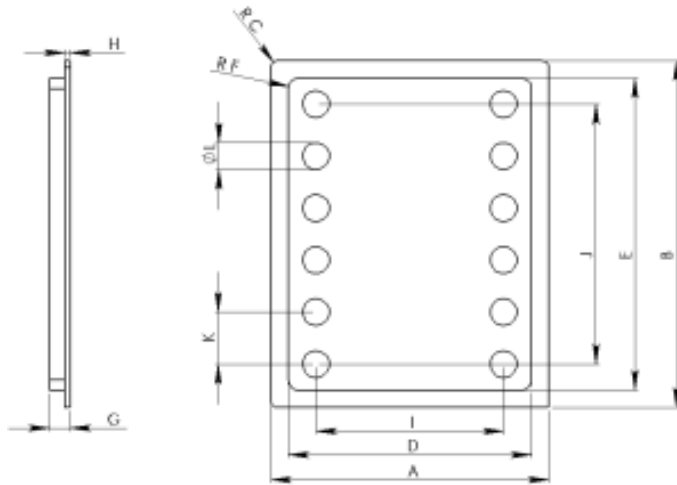

400 Kuller Road  
 Clifton, NJ 07011  
 Phone: 973.253.0500  
 Fax: 973.253.9611  
 Web: www.coining.com  
 E-mail: sales@coining.com

## DL • Dual In-Line Platforms • Coined Headers

	A	B	C	D	E	F	G	H	I	J	K	L
CTI Part#	Overall Width	Overall Length	OD Radius	Body Width	Body Length	Body Radius	OAH	Flange Thickness	Hole Grid Width	Hole Grid Length	Hole Pitch	Hole Dia
DL-520-15B	0.495	0.792	0.080	0.300	0.688	0.035	0.060	0.015	0.300	0.600	0.100	0.056
DL-520-B	0.495	0.795	0.080	0.397	0.698	0.035	0.060	0.015	0.300	0.600	0.100	0.056
DL-788-12A	0.495	0.795	0.080	0.400	0.700	0.032	0.060	0.015	0.300	0.600		0.056
DL-788-13A	0.495	0.795	0.080	0.400	0.700	0.032	0.060	0.015	0.300	0.600	0.100	0.056
DL-788-16B	0.495	0.795	0.080	0.397	0.698	0.035	0.060	0.015	0.300	0.600		0.056
DL-524-18B	0.495	0.797	0.080	0.397	0.699	0.030	0.060	0.015	0.300	0.600	0.200	0.056
DL-524-A	0.495	0.797	0.080	0.397	0.698	0.035	0.060	0.015	0.300	0.600	0.100	0.056
DL-008	0.495	0.815	0.080	0.407	0.727	0.040	0.060	0.015	0.300	0.600	0.100	0.056
DL-524-41B	0.496	0.798	0.080	0.398	0.698	0.030	0.060	0.015	0.300	0.600	0.200	0.056
DL-443-02B	0.496	1.069	0.080	0.397	0.969	0.030	0.060	0.015	0.300	0.800	0.100	0.060
DL-288-19B	0.496	1.369	0.080	0.397	1.269	0.080	0.060	0.015	0.300	2.140	0.100	0.056
DL-520-02A	0.497	0.698	0.080	0.397	0.698	0.030	0.060	0.015	0.300	0.600	0.100	0.056
DL-520-33A	0.497	0.787	0.080	0.398	0.698	0.030	0.060	0.015	0.300	0.600	0.200	0.056
DL-524-39B	0.497	0.796	0.080	0.397	0.698	0.030	0.060	0.015	0.300	0.600	0.100	0.056
DL-520-02B	0.497	0.798	0.080	0.397	0.698	0.030	0.060	0.015	0.300	0.600	0.100	0.056
DL-520-07A	0.497	0.798	0.080	0.397	0.698	0.032	0.060		0.300	0.600		0.056
DL-520-08A	0.497	0.798	0.080	0.397	0.698	0.030	0.060	0.015	0.300	0.600	0.100	0.056
DL-520-12A	0.497	0.798	0.080	0.397	0.698	0.030	0.060	0.015	0.300	0.600	0.100	0.056
DL-520-12B	0.497	0.798	0.080	0.397	0.698	0.032	0.060		0.300	0.600	N/A	0.056
DL-520-16B	0.497	0.798	0.080	0.397	0.698	0.030	0.060	0.015	0.300	0.600	0.100	0.056
DL-520-18B	0.497	0.798	0.080	0.397	0.698	0.030	0.060	0.015	0.300	0.600	0.100	0.056
DL-520-18B	0.497	0.798	0.080	0.397	0.698	0.030	0.060	0.015	0.300	0.600	0.100	0.056
DL-520-19B	0.497	0.798	0.080	0.397	0.698	0.030	0.060	0.015	0.300	0.600	0.100	0.056
DL-520-20B	0.497	0.798	0.080	0.397	0.698	0.030	0.060	0.015	0.300	0.600	0.100	0.056
DL-520-23A	0.497	0.798	0.080	0.397	0.698	0.030	0.060	0.015	0.300	0.600	0.100	0.056
DL-520-23B	0.497	0.798	0.080	0.397	0.698	0.030	0.060	0.015	0.300	0.600	0.100	0.056
DL-520-26B	0.497	0.798	0.080	0.397	0.698	0.030	0.060	0.015	0.300	0.600	0.100	0.056
DL-520-26B	0.497	0.798	0.080	0.397	0.698	0.030	0.060	0.015	0.300	0.600	0.100	0.056
DL-520-27A	0.497	0.798	0.080	0.397	0.698	0.030	0.060	0.015	0.300	0.600	0.100	0.056
DL-520-28B	0.497	0.798	0.080	0.397	0.698	0.030	0.060	0.015	0.300	0.600	0.100	0.056

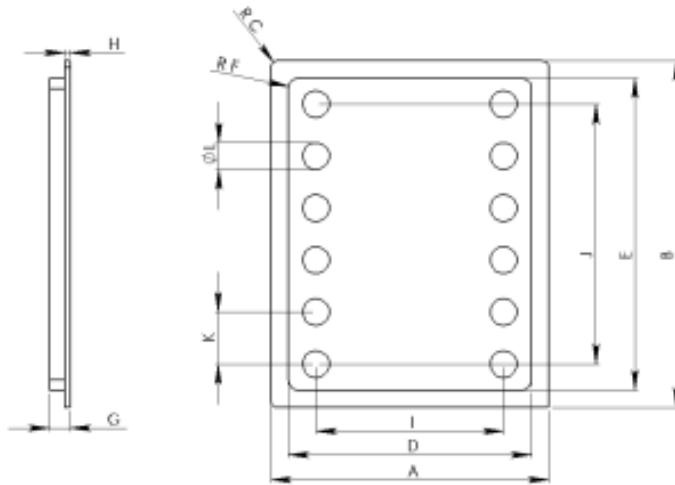

400 Kuller Road  
 Clifton, NJ 07011  
 Phone: 973.253.0500  
 Fax: 973.253.9611  
 Web: www.coining.com  
 E-mail: sales@coining.com

## DL • Dual In-Line Platforms • Coined Headers

	A	B	C	D	E	F	G	H	I	J	K	L
CTI Part#	Overall Width	Overall Length	OD Radius	Body Width	Body Length	Body Radius	OAH	Flange Thickness	Hole Grid Width	Hole Grid Length	Hole Pitch	Hole Dia
DL-520-30B	0.497	0.798	0.080	0.397	0.698	0.030	0.060	0.015	0.300	0.600	0.100	0.056
DL-520-31B	0.497	0.798	0.080	0.397	0.698	0.030	0.060	0.015	0.300	0.600	0.100	0.056
DL-520-32B	0.497	0.798	0.080	0.397	0.698	0.080	0.060	0.015	0.300	0.600	0.100	0.056
DL-520-38B	0.497	0.798	0.080	0.397	0.698	0.030	0.060	0.015	0.300	0.600	0.100	0.056
DL-520-42B	0.497	0.798	0.080	0.397	0.698	0.030	0.060	0.015	0.300	0.600	0.100	0.056
DL-520-48 B	0.497	0.798	0.076	0.397	0.698	0.030	0.060	0.015	0.300	0.600	0.100	0.056
DL-520-A	0.497	0.798	0.080	0.397	0.698	0.030	0.060	0.015	0.300	0.600	0.100	0.056
DL-520-C	0.497	0.798	0.085	0.397	0.698	0.033	0.059	0.015	0.300	0.600	0.100	0.056
DL-524-02A	0.497	0.798	0.080	0.397	0.698	0.030	0.060	0.015	0.300	0.698	0.100	0.056
DL-524-02B	0.497	0.798	0.080	0.397	0.698	0.030	0.060	0.015	0.300	0.698	0.100	0.056
DL-524-04B	0.497	0.798	0.080	0.397	0.698	0.030	0.060	0.015	0.300	0.600	0.100	0.056
DL-524-05B	0.497	0.798	0.080	0.397	0.698	0.030	0.060	0.015	0.300	0.600	0.100	0.056
DL-524-08B	0.497	0.798	0.080	0.397	0.698	0.030	0.060	0.015	0.300	0.600	0.100	0.056
DL-524-09B	0.497	0.798	0.080	0.397	0.698	0.032	0.060	N/A	0.300	0.600		0.056
DL-524-11B	0.497	0.798	0.080	0.397	0.698	0.030	0.060	0.015	0.300	0.600		0.056
DL-524-16B	0.497	0.798	0.080	0.397	0.698	0.030	0.060	0.015	0.300	0.600	0.300	0.056
DL-524-17B	0.497	0.798	0.080	0.397	0.698	0.032	0.060	N/A	0.300	0.600		0.056
DL-524-20B	0.497	0.798	0.080	0.397	0.698	0.030	0.060	0.015	0.300	0.600	0.100	0.056
DL-524-24A	0.497	0.798	0.080	0.397	0.698	0.032	0.060	N/A	0.300	0.600	0.100	0.056
DL-524-26B	0.497	0.798	0.080	0.397	0.698	0.030	0.060	0.015	0.300	0.600	0.100	0.056
DL-524-30B	0.497	0.798	0.080	0.397	0.698	0.030	0.060	0.015	0.300	0.600	0.100	0.056
DL-524-31B	0.497	0.798	0.080	0.397	0.698	0.030	0.060	0.015	0.300	0.600	0.100	0.056
DL-524-32B	0.497	0.798	0.080	0.397	0.698	0.030	0.060	0.015	0.300	0.600	0.100	0.056
DL-524-34B	0.497	0.798	0.080	0.397	0.698	0.030	0.060	0.015	0.300	0.600	0.100	0.056
DL-524-35B	0.497	0.798	0.080	0.397	0.698	0.030	0.060	0.015	0.300	0.600	0.100	0.056
DL-524-36B	0.497	0.798	0.080	0.397	0.698	0.030	0.060	0.015	0.300	0.600	0.100	0.056
DL-524-37B	0.497	0.798	0.080	0.300	0.698	0.030	0.060	0.015	0.300	0.600	0.100	0.056
DL-524-38B	0.497	0.798	0.080	0.397	0.698	0.039	0.060	0.015	0.300	0.600	0.100	0.056
DL-524-B	0.497	0.798	0.080	0.397	0.698	0.030	0.060	0.015	0.300	0.600	0.100	0.056
DL-524-C	0.497	0.798	0.080	0.397	0.698	0.025	0.060	0.015	0.300	0.600	0.100	0.056

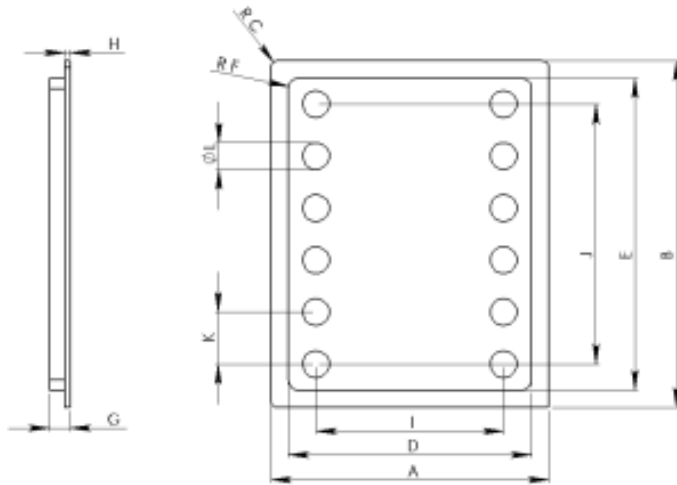

**400 Kuller Road**  
**Clifton, NJ 07011**  
**Phone: 973.253.0500**  
**Fax: 973.253.9611**  
**Web: www.coining.com**  
**E-mail: sales@coining.com**

## DL • Dual In-Line Platforms • Coined Headers

	A	B	C	D	E	F	G	H	I	J	K	L
CTI Part#	Overall Width	Overall Length	OD Radius	Body Width	Body Length	Body Radius	OAH	Flange Thickness	Hole Grid Width	Hole Grid Length	Hole Pitch	Hole Dia
DL-275	0.497	0.854	0.080	0.397	0.769	0.035	0.060	0.015	0.300	0.600	0.100	0.056
DL-838-02A	0.497	0.869	0.080	0.397	0.796	0.035	0.060	0.015	0.300	0.600	0.100	0.056
DL-838-06A	0.497	0.869	0.080	0.397	0.769	0.030	0.060	0.015	0.300	0.600	0.100	0.056
DL-838-10A	0.497	0.869	0.080	0.397	0.769	0.035	0.060	0.015	0.300	0.600	0.100	0.056
DL-838-11B	0.497	0.869	0.080	0.397	0.769	0.034	0.060	0.015	0.300	0.600	0.100	0.056
DL-838-12A	0.497	0.869	0.080	0.397	0.769	0.035	0.040	0.015	0.300	0.600	0.100	0.056
DL-838-16A	0.497	0.869	0.080	0.397	0.769	0.030	0.060	0.015	0.300	0.600	0.100	0.056
DL-838-19B	0.497	0.869	0.080	0.397	0.769	0.035	0.060	0.015	0.300	0.600	0.100	0.056
DL-838-25A	0.497	0.869	0.080	0.397	0.769	0.035	0.060	0.015	0.300	0.600	0.100	0.056
DL-838-31B	0.497	0.869	0.080	0.397	0.769	0.035	0.060	0.015	0.300	0.600	0.100	0.056
DL-838-20A	0.497	0.870	0.080	0.398	0.770	0.035	0.040	0.015	0.300	0.600	0.100	0.056
DL-838-33B	0.497	0.870	0.080	0.398	0.770	0.031	0.060	0.015	0.300	0.600	0.100	0.056
DL-871-25A	0.497	0.969	0.080	0.397	0.869	0.030	0.060	0.015	0.300	0.700	0.100	0.510
DL-871-04A	0.497	0.970	0.080	0.397	0.870	0.030	0.060	0.015	0.300	0.500	0.100	0.056
DL-443	0.497	1.069	0.080	0.397	0.969	0.035	0.060	0.014	0.300	0.800	0.100	0.056
DL-443-04A	0.497	1.069	0.080	0.397	0.969	0.035	0.060	0.015	0.300	0.800	0.100	0.056
DL-443-05B	0.497	1.069	0.080	0.397	0.968	0.035	0.060	0.015	0.300	0.800	0.100	0.056
DL-443-12A	0.497	1.069	0.080	0.397	0.969	0.035	0.060	0.015	0.300	0.800	0.100	0.056
DL-443-12B	0.497	1.069	0.080	0.397	0.969	0.035	0.060	0.015	0.300	0.800	0.100	0.056
DL-443-16G	0.497	1.069	0.080	0.396	0.969	0.035	0.060	0.015	0.300	0.800		0.056
DL-411-02A	0.498	0.498	0.086	0.398	0.398	0.039	0.060	0.015	0.297	0.297	0.099	0.056
DL-411-01A	0.498	0.498	0.086	0.398	0.398	0.039	0.061	0.013	0.396		0.099	0.056
DL-411-06A	0.498	0.498	0.080	0.398	0.398	0.035	0.060	0.015	0.300	0.300	0.120	0.056
DL-411-08B	0.498	0.498	0.086	0.398	0.398	0.039	0.054	0.014	0.297	0.297	0.099	0.057
DL-411-A	0.498	0.498	0.086	0.398	0.398	0.039	0.060	0.015	0.297	0.297	0.099	0.056
DL-411-B	0.498	0.498	0.086	0.398	0.398	0.039	0.054	0.014	0.300	0.300	0.100	0.056
DL-520-46A	0.498	0.759	0.087	0.400	0.700	0.043	0.059	0.016	0.300	0.600		0.057
DL-520-12A	0.498	0.798	0.080	0.398	0.698	0.030	0.060	0.015	0.300	0.600	0.120	0.056
DL-520-14B	0.498	0.798	0.080	0.398	0.698	0.030	0.060	0.015	0.300	0.600	0.100	0.056
DL-520-35B	0.498	0.798	0.080	0.397	0.698	0.030	0.039	0.015	0.300	0.600	0.100	0.056

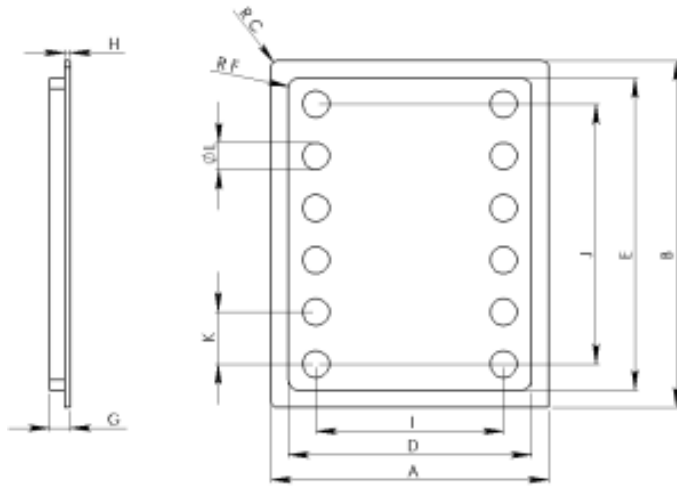

400 Kuller Road  
 Clifton, NJ 07011  
 Phone: 973.253.0500  
 Fax: 973.253.9611  
 Web: www.coining.com  
 E-mail: sales@coining.com

## DL • Dual In-Line Platforms • Coined Headers

	A	B	C	D	E	F	G	H	I	J	K	L
CTI Part#	Overall Width	Overall Length	OD Radius	Body Width	Body Length	Body Radius	OAH	Flange Thickness	Hole Grid Width	Hole Grid Length	Hole Pitch	Hole Dia
DL-520-40B	0.498	0.798	0.080	0.398	0.698	0.030	0.060	0.015	0.300	0.600	0.100	0.056
DL-520-44B	0.498	0.798	0.080	0.397	0.698	0.030	0.060	0.015	0.300	0.600	0.100	0.056
DL-838-05B	0.498	0.870	0.079	0.398	0.768	0.030	0.059	0.015	0.398	0.769	0.100	0.057
DL-838-064	0.498	0.870	0.080	0.398	0.770	0.030	0.060	0.015	0.300	0.600	0.100	0.056
DL-838-08B	0.498	0.870	0.118	0.398	0.770	0.030	0.059	0.015	0.300	0.600	0.100	0.057
DL-838-27A	0.498	0.870	0.080	0.398	0.770	0.030	0.060	0.015	0.300	0.600	0.100	0.056
DL-838-27B	0.498	0.870	0.080	0.398	0.770	0.030	0.059	0.015	0.300	0.600	0.100	0.057
DL-838-A	0.498	0.870	0.080	0.398	0.770	0.035	0.060	0.015	0.300	0.600	0.100	0.056
DL-838-B	0.498	0.870	0.080	0.398	0.770	0.030	0.060	0.015	0.300	0.600	0.100	0.056
DL-871	0.498	0.969	0.080	0.397	0.869	0.030	0.060	0.014	0.300	0.700	0.100	0.056
DL-871-02B	0.498	0.969	0.080	0.397	0.869	0.030	0.060	0.015	0.300	0.700	0.100	0.056
DL-871-16A	0.498	0.969	0.080	0.397	0.869	0.030	0.060	0.014	0.300	0.700	0.100	0.056
DL-871-17B	0.498	0.969	0.080	0.397	0.869	0.030	0.060	0.015	0.300	0.700	0.100	0.056
DL-871-18A	0.498	0.969	0.080	0.397	0.869	0.030	0.060	0.015	0.300	0.700	0.100	0.056
DL-450-02A	0.498	0.970	0.080	0.398	0.870	0.030	0.060	0.015	0.300	0.500	0.100	0.056
DL-871-02A	0.498	0.970	0.080	0.397	8.690	0.030	0.060	0.017	0.300	0.700	0.100	0.056
DL-520-08B	0.499	0.795	0.080	0.390	0.698	0.033	0.059	0.015	0.300	0.600		0.056
DL-104	0.500	0.795	0.087	0.402	0.698		0.060	0.015	0.300	0.600		
DL-339	0.500	0.820	0.015				0.040		0.300	0.600	0.100	0.056
DL-632	0.500	1.000	0.015				0.060		0.300	0.800	0.100	0.056
DL-002	0.510	0.810	0.080	0.420	0.720	0.030	0.060	0.015	0.300	0.600	0.100	0.056
DL-446	0.520	0.880	0.080	0.450	0.750	0.035	0.060	0.015	0.300	0.600	0.200	0.100
DL-446-06A	0.520	0.880	0.080	0.450	0.750	0.035	0.060	0.015	0.300	0.600	0.200	0.100
DL-195	0.525	0.945	0.123	0.405	0.825	0.063	0.060	0.020	0.300	0.700	0.100	0.060
DL-195-02A	0.525	0.945	0.123	0.405	0.825	0.063	0.060	0.020	0.300	0.700	0.100	0.060
DL-664	0.525	1.560	0.080	0.435	1.470	0.035	0.060	0.015	0.300	1.300	0.100	0.060
DL-166	0.534	1.232	0.105	0.458	0.802	0.080	0.060		0.300	0.600		
DL-378	0.540	0.740	0.045	0.504	0.704	0.027	0.040	0.015	0.400	0.600	0.100	0.042
DL-200	0.560	1.180	ANGLE	0.397	0.769	0.035	0.060	0.028	0.300	0.600	0.100	0.056
DL-155	0.568	0.768	0.080	0.500	0.700	0.045	0.060	0.018	0.400	0.600	0.100	0.056





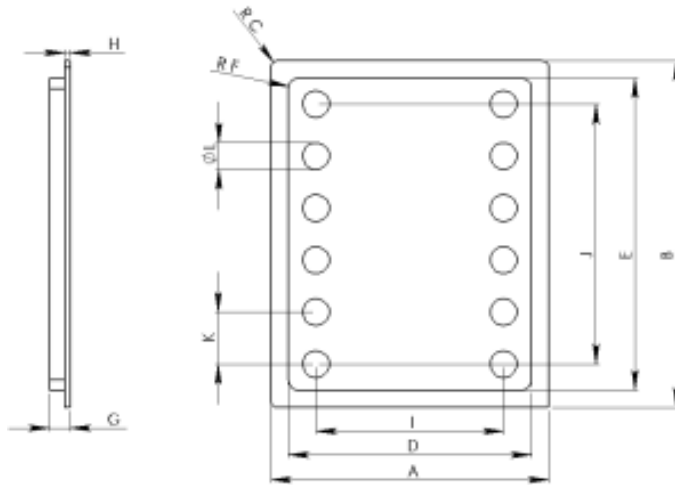

400 Kuller Road  
 Clifton, NJ 07011  
 Phone: 973.253.0500  
 Fax: 973.253.9611  
 Web: www.coining.com  
 E-mail: sales@coining.com

## DL • Dual In-Line Platforms • Coined Headers

	A	B	C	D	E	F	G	H	I	J	K	L
CTI Part#	Overall Width	Overall Length	OD Radius	Body Width	Body Length	Body Radius	OAH	Flange Thickness	Hole Grid Width	Hole Grid Length	Hole Pitch	Hole Dia
DL-127-01A	0.775	0.775	0.046	0.685	0.685	0.046	0.060	0.015	0.600	0.600	0.100	0.056
DL-127-02A	0.775	0.775	0.046	0.685	0.685	0.046	0.060	0.015	0.600	0.600	0.100	0.056
DL-127-04G	0.775	0.775	0.047	0.685	0.685	0.027	0.059	0.015	0.600	0.600	0.100	0.056
DL-127-05G	0.775	0.775	0.047	0.685	0.685	0.027	0.059	0.015	0.600	0.600	0.100	0.056
DL-127-08A	0.775	0.775	0.045	0.685	0.685	0.045	0.060	0.015	0.600	0.600	0.100	0.056
DL-127-11B	0.775	0.775	0.045	0.685	0.685	0.045	0.050	0.015	0.697	0.597	0.200	0.058
DL-127-12A	0.775	0.775	0.045	0.685	0.685	0.035	0.060	0.015	0.600	0.600	0.100	0.035
DL-127-17A	0.775	0.775	0.046	0.685	0.685	0.046	0.060	0.015	0.600	0.600	0.100	0.056
DL-242	0.775	0.975	0.046	0.691	0.891	0.046	0.060	0.015	0.600	0.800	0.100	0.056
DL-242-06A	0.775	0.975	0.046	0.691	0.891	0.046	0.040	0.015	0.600	0.800	0.100	0.056
DL-344-1	0.780	1.320	0.015	0.680	1.220	0.030	0.060	0.015	0.600	1.100	0.100	0.056
DL-108-02G	0.787	1.115	0.071	0.700	1.029	0.027	0.059	0.015	0.600	0.900	0.100	0.056
DL-013-02A	0.787	1.116	0.071	0.700	0.900	0.027	0.059	0.015	0.600	0.900	0.100	0.056
DL-013-02G	0.787	1.116	0.071	0.700	1.029	0.027	0.059	0.015	0.600	0.900	0.100	0.056
DL-020-02B	0.794	0.794	0.079	0.717	0.717	0.040	0.039	0.015	0.600	0.600		0.056
DL-020-03B	0.794	0.794	0.079	0.717	0.717	0.040	0.039	0.015	0.600	0.600		0.056
DL-020-04B	0.794	0.794	0.079	0.717	0.717	0.040	0.039	0.015	0.600	0.600		0.056
DL-020-05B	0.794	0.794	0.079	0.717	0.717	0.040	0.039	0.015	0.600	0.600		0.056
DL-903	0.794	0.969	0.080	0.694	0.869	0.030	0.060	0.014	0.600	0.700	0.100	0.056
DL-903-02B	0.794	0.969	0.080	0.694	0.869	0.030	0.060	0.015	0.600	0.700	0.100	0.056
DL-903-03B	0.794	0.969	0.080	0.694	0.869	0.030	0.060	0.015	0.600	0.700	0.100	0.056
DL-903-05B	0.794	0.969	0.080	0.694	0.869	0.030	0.060	0.015	0.600	0.700	0.100	0.056
DL-903-10A	0.794	0.969	0.080	0.694	0.869	0.035	0.060	0.015	0.694	0.869	0.100	0.056
DL-903-17A	0.794	0.969	0.080	0.694	0.869	0.030	0.060	0.015	0.600	0.700	0.100	0.056
DL-903-20A	0.794	0.969	0.080	0.600	0.700	0.030	0.060	0.015	0.600	0.700	0.100	0.056
DL-903-29A	0.794	0.969	0.080	0.694	0.869	0.035	0.060	0.015	0.600	0.700	0.100	0.056
DL-903-45B	0.794	0.969	0.080	0.694	0.869	0.030	0.060	0.015	0.600	0.700	0.100	0.056
DL-517-02A	0.794	1.000	0.080	0.695	0.900	0.030	0.059	0.015	0.600	0.800	0.100	0.056
DL-941-14A	0.794	1.269	0.080	0.694	1.269	0.030	0.060	0.015	0.600	1.100	0.100	0.056
DL-133	0.794	1.369	0.080	0.694	1.269	0.030	0.040	0.015	0.600	1.100	0.050	0.038

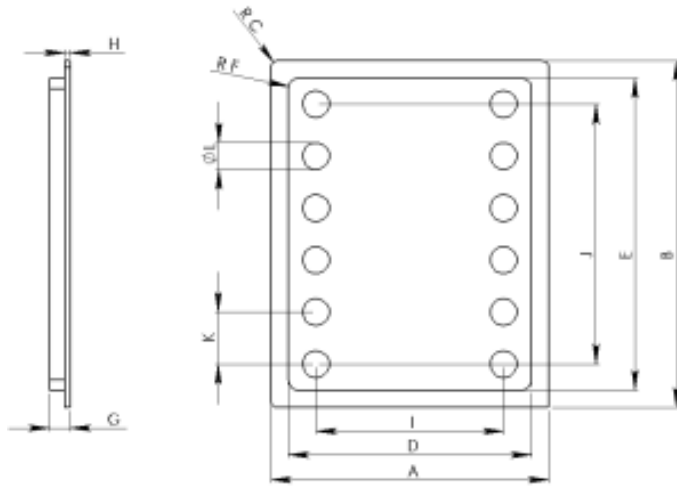

400 Kuller Road  
 Clifton, NJ 07011  
 Phone: 973.253.0500  
 Fax: 973.253.9611  
 Web: www.coining.com  
 E-mail: sales@coining.com

## DL • Dual In-Line Platforms • Coined Headers

	A	B	C	D	E	F	G	H	I	J	K	L
CTI Part#	Overall Width	Overall Length	OD Radius	Body Width	Body Length	Body Radius	OAH	Flange Thickness	Hole Grid Width	Hole Grid Length	Hole Pitch	Hole Dia
DL-941-01A	0.794	1.369	0.080	0.694	1.269	0.030	0.060	0.015	0.600	1.100	0.100	0.056
DL-941-02A	0.794	1.369	0.080	0.694	1.269	0.030	0.060	0.015	0.600	1.100	0.100	0.056
DL-941-02B	0.794	1.369	0.080	0.694	1.269	0.030	0.060	0.015	0.600	1.100	0.100	0.056
DL-941-02B	0.794	1.369	0.080	0.694	1.269	0.030	0.060	0.015	0.600	1.100	0.100	0.056
DL-941-02G	0.794	1.369	0.080	0.694	1.269	0.030	0.060	0.015	0.600	1.100	0.100	0.056
DL-941-12B	0.794	1.369	0.080	0.694	1.268	0.030	0.760	0.060	0.600	1.100	0.100	0.056
DL-941-32A	0.794	1.369	0.080	0.694	1.269	0.030	0.060	0.015	0.600	1.100	0.100	0.056
DL-941-38B	0.794	1.369	0.080	0.694	1.269	0.030	0.060	0.015	0.600	1.100	0.100	0.056
DL-941-53A	0.794	1.369	0.080	0.694	1.269		0.059	0.021	0.600	1.100	0.100	0.056
DL-941-54A	0.794	1.369	0.079	0.694	1.269	0.030	0.060	0.015	0.600	1.100	0.100	0.056
DL-941-54A	0.794	1.369	0.080	0.694	1.269	0.030	0.060	0.015	0.600	1.100	0.100	0.056
DL-941-A	0.794	1.369	0.080	0.694	1.269	0.030	0.060	0.014	0.600	1.100	0.100	0.056
DL-941-B	0.794	1.369	0.080	0.694	1.269	0.030	0.060	0.015	0.400	1.000	0.200	0.140
DL-941-08A	0.794	1.370	0.080	0.694	1.270	0.030	0.060	0.015	0.600	1.100	0.100	0.056
DL-955	0.795	0.950	0.080	0.695	0.850	0.030	0.060	0.015	0.600	0.700	0.100	0.056
DL-903-04A	0.795	0.970	0.080	0.695	0.870	0.030	0.060	0.015	0.600	0.700	0.100	0.056
DL-903-05A	0.795	0.970	0.080	0.695	0.870	0.030	0.060	0.015	0.600	0.700	0.100	0.056
DL-903-16A	0.795	0.970	0.060	0.695	0.870	0.030	0.060	0.015	0.600	0.700	0.100	0.056
DL-903-19A	0.795	0.970	0.060	0.695	0.870	0.030	0.060	0.015	0.600	0.700	0.100	0.056
DL-903-22B	0.795	0.970	0.080	0.695	0.870	0.030	0.060	0.015	0.600	0.700	0.100	0.056
DL-903-24B	0.795	0.970	0.080	0.695	0.870	0.030	0.060	0.015	0.600	0.700	0.100	0.056
DL-903-27B	0.795	0.970	0.080	0.695	0.870	0.030	0.060	0.015	0.600	0.700	0.100	0.056
DL-903-37B	0.795	0.970	0.080	0.694	0.700	0.030	0.060	0.015	0.600	0.700	0.100	0.056
DL-903-38B	0.795	0.970	0.080	0.694	0.869	0.030	0.060	0.015	0.600	0.700	0.100	0.056
DL-903-42B	0.795	0.970	0.080	0.495	0.870	0.030	0.060	0.015	0.600	0.700	0.300	0.056
DL-903-46B	0.795	0.970	0.080	0.694	0.869	0.030	0.060	0.015	0.600	0.700	0.200	0.056
DL-903-54B	0.795	0.970	0.080	0.695	0.870	0.030	0.060		0.600	0.700	0.100	0.030
DL-517-03G	0.795	1.000	0.079	0.695	0.899	0.031	0.059	0.015	0.600	0.800	0.100	0.055
DL-903-02G	0.795	1.000	0.078	0.694	0.899	0.031	0.059	0.015	0.600	0.800	0.100	0.031
DL-903-34G	0.795	1.000	0.079	0.694	0.899	0.031	0.059	0.015	0.600	0.800	0.100	0.055

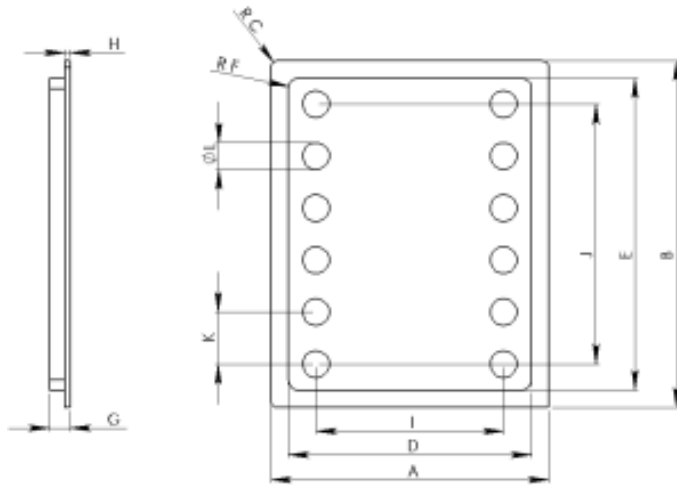

400 Kuller Road  
 Clifton, NJ 07011  
 Phone: 973.253.0500  
 Fax: 973.253.9611  
 Web: www.coining.com  
 E-mail: sales@coining.com

## DL • Dual In-Line Platforms • Coined Headers

	A	B	C	D	E	F	G	H	I	J	K	L
CTI Part#	Overall Width	Overall Length	OD Radius	Body Width	Body Length	Body Radius	OAH	Flange Thickness	Hole Grid Width	Hole Grid Length	Hole Pitch	Hole Dia
DL-517-B	0.795	1.000	0.079	0.695	0.900	0.031	0.059	0.015	0.600	0.800	0.100	0.056
DL-517-A	0.795	1.001	0.080	0.719	0.925	0.030	0.060	0.015	0.600	0.800	0.100	0.056
DL-381	0.795	1.295	0.046	0.686	1.186	0.046	0.040	0.015	0.600	1.100	0.100	0.042
DL-941-04A	0.795	1.370	0.080	0.695	1.270	0.035	0.060	0.015	0.600	1.100	0.100	0.056
DL-941-05A	0.795	1.370	0.078	0.694	1.269	0.031	0.059	0.016	0.600	1.100	0.100	0.055
DL-941-13A	0.795	1.370	0.080	0.695	1.270	0.035	0.060	0.015	0.600	1.100	0.100	0.056
DL-941-40G	0.795	1.370	0.080	0.694	1.269	0.030	0.060	0.015	0.600	1.100	0.100	0.056
DL-941-41A	0.795	1.370	0.080	0.695	1.270	0.080	0.060	0.015	0.600	1.100	0.200	0.056
DL-941-43A	0.795	1.370	0.080	0.694	1.100	0.030	0.060	0.015	0.600	1.100	0.100	0.056
DL-941-46G	0.795	1.370	0.080	0.694	1.269	0.030	0.060	0.015	0.600	1.100	0.100	0.056
DL-941-52B	0.795	1.370	0.080	0.695	1.270	0.030	0.060	0.016	0.600	1.270	0.100	0.056
DL-941-55A	0.795	1.370	0.079	0.694	1.268	0.029	0.059	0.015	0.600	1.100	0.100	0.055
DL-539	0.795	2.146	ANGLE	0.694	1.269	0.035	0.060	0.045	0.500	1.100	0.100	0.056
DL-539-04B	0.795	2.146	0.173	0.694	1.269	0.035	0.060	0.045	1.100		0.100	0.056
DL-216-04B	0.795	0.870	0.081	0.695	0.770	0.028	0.060	0.015	0.600	0.615	0.200	0.069
DL-941-27B	0.796	1.370	0.070	0.695	1.270	0.020	0.100	0.006	0.400	1.000	0.200	0.140
DL-941-57A	0.796	1.371	0.080	0.697	1.272	0.030	0.060	0.015	0.600	1.100	0.100	0.056
DL-903-49A	0.798	0.973	0.084	0.695	0.869	0.034	0.063	0.015	0.600	0.700	0.100	0.057
DL-108	0.822	1.131	0.079	0.720	1.029	0.028	0.060	0.023	0.600	0.900	0.100	0.056
DL-108-05A	0.822	1.131	0.079	0.720	1.029	0.028	0.060	0.015	0.600	0.900	0.100	0.055
DL-446-07A	0.880	0.520	0.070	0.810	0.450	0.035	0.060	0.005	0.300	0.600	0.200	0.100
DL-510-06G	0.898	0.898	0.079	0.787	0.787	0.043	0.060	0.015	0.600	0.600	0.150	0.056
DL-557	0.899	0.899	0.086	0.799	0.799	0.039	0.060	0.015	0.600	0.700	0.100	0.056
DL-510-04B	0.900	0.900	0.086	0.800	0.800	0.039	0.060	0.015	0.600	0.700	0.100	0.056
DL-557-04A	0.900	0.900	0.086	0.800	0.800	0.039	0.060	0.015	0.600	0.700	0.100	0.056
DL-557-04B	0.900	0.900	0.086	0.799	0.799	0.039	0.060	0.015	0.600	0.700	0.100	0.056
DL-557-05A	0.900	0.900	0.086	0.800	0.800	0.039	0.060	0.015	0.600	0.700	0.100	0.056
DL-510	0.900	0.900	0.086	0.800	0.800	0.039	0.060	0.015	ODD		ODD	0.056
DL-575-B	0.947	1.247	0.080	0.907	1.207	0.060	0.040	0.015	0.800	1.100	0.100	0.056
DL-019-04B	0.951	0.951	0.094	0.909	0.909		0.042		0.750	0.750	0.125	0.056

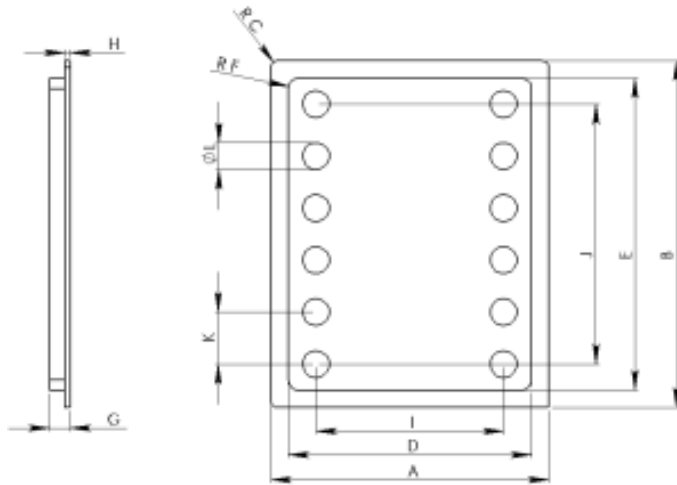

400 Kuller Road  
 Clifton, NJ 07011  
 Phone: 973.253.0500  
 Fax: 973.253.9611  
 Web: www.coining.com  
 E-mail: sales@coining.com

## DL • Dual In-Line Platforms • Coined Headers

	A	B	C	D	E	F	G	H	I	J	K	L
CTI Part#	Overall Width	Overall Length	OD Radius	Body Width	Body Length	Body Radius	OAH	Flange Thickness	Hole Grid Width	Hole Grid Length	Hole Pitch	Hole Dia
DL-019-08B	0.951	0.951	0.094				0.042		0.750	0.750	0.125	0.069
DL-575-A	0.970	0.970	0.080	0.890	1.190	0.060	0.060	0.015	0.800	1.100	0.100	0.056
DL-126	0.975	0.975	0.046	0.940	0.940	0.046	0.040	0.015	0.800	0.800	0.100	0.042
DL-590	0.950	1.280	0.046	0.885	1.185	0.046	0.040	0.015	0.800	1.100	0.100	0.042
DL-547	0.990	0.990	0.010				0.062		0.750	0.750	0.250	0.070
DL-742	0.990	1.990	0.080	0.900	1.900	0.030	0.060	0.015	0.800	1.800	0.100	0.056
DL-742-05A	0.990	1.990	0.080	0.900	1.902	0.030	0.060	0.015	0.800	1.800		0.056
DL-742-09A	0.990	1.990	0.080	0.904	1.904	0.035	0.010	N/A	N/A		N/A	N/A
DL-748-02A	0.990	1.990	0.080	0.900	1.900	0.030	0.060	0.015	0.800	1.800	0.100	0.056
DL-561	0.992	0.992	SQUAR	0.910	0.910	ANGLE	0.060	0.010	0.600	0.750	0.200	0.081
DL-383	0.995	1.495	0.096	0.886	1.386	0.046	0.040	0.015	0.800	1.300	0.100	0.042
DL-588	0.995	1.995	0.046	0.886	1.886	0.046	0.040	0.015	0.800	1.800	0.100	0.042
DL-405-01A	0.996	0.996	0.079	0.896	0.896	0.031	0.059	0.015	0.800	0.800	0.100	0.031
DL-405	0.996	0.996	0.079	0.896	0.896	0.031	0.059	0.015	0.800	0.800	0.100	0.056
DL-588-04A	0.996	2.000	N/A	0.885	1.886	N/A	0.050		0.800	1.800	0.100	0.045
DL-581-06A	1.000	1.000	0.090	0.900	0.900	0.046	0.060	0.015	0.800	0.800	0.200	0.070
DL-581-07A	1.000	1.000	0.097	0.900	0.900	0.046	0.060	0.015	0.800	0.800	0.200	0.056
DL-581-12A	1.000	1.000	0.097	0.900	0.900	0.046	0.060	0.015	0.700	1.200		0.056
DL-333-1	1.000	1.000	0.025				0.040		0.750	0.750	0.250	0.069
DL-410	1.000	1.000	0.010				0.060		0.600	0.750	0.200	0.081
DL-581	1.000	1.000	0.097	0.900	0.900	0.046	0.060	0.015	0.800	0.800	0.100	0.056
DL-812	1.000	1.500	0.085	0.900	1.400	0.035	0.060	0.015	0.800	1.300	0.100	0.056
DL-812-04A	1.000	1.500	0.085	0.900	1.400	0.035	0.060	0.015	0.800	1.300	0.100	0.056
DL-812-11G	1.000	1.500	0.079	0.900	1.300	0.027	0.059	0.015	0.800	1.300	0.100	0.056
DL-812-13A	1.000	1.500	0.085	0.900	1.400	0.035	0.060	0.015	0.800	1.300	0.200	0.056
DL-812-15G	1.000	1.500	0.085	0.900	1.400	0.035	0.060	0.015	0.800	1.300	0.200	0.056
DL-812-16G	1.000	1.500	0.079	0.900	1.400	0.027	0.059	0.015	0.800	1.300	0.100	0.056
DL-812-17G	1.000	1.500	0.079	0.900	1.400	0.027	0.059	0.015	0.800	1.300	0.100	0.056
DL-812-18G	1.000	1.500	0.079	0.900	1.400	0.027	0.059	0.015	0.800	1.300	0.100	0.056
DL-015-01B	1.003	1.350	0.079	0.906	1.260	0.059	0.054		0.700	1.000	0.300	0.079

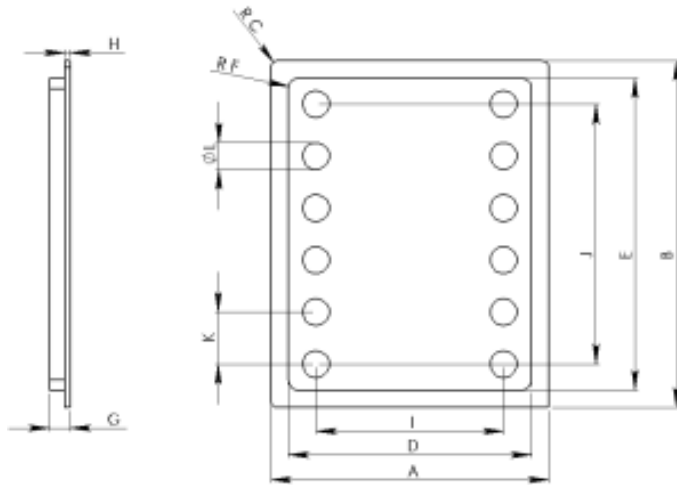

400 Kuller Road  
 Clifton, NJ 07011  
 Phone: 973.253.0500  
 Fax: 973.253.9611  
 Web: www.coining.com  
 E-mail: sales@coining.com

## DL • Dual In-Line Platforms • Coined Headers

	A	B	C	D	E	F	G	H	I	J	K	L
CTI Part#	Overall Width	Overall Length	OD Radius	Body Width	Body Length	Body Radius	OAH	Flange Thickness	Hole Grid Width	Hole Grid Length	Hole Pitch	Hole Dia
DL-004-04B	1.008	1.307	0.150	0.858	1.157	0.059	0.059	0.031	0.655		0.131	0.075
DL-006	1.012	1.212	0.080	0.917	1.154	0.047	0.060	0.020	ODD			0.094
DL-006-04B	1.012	1.250	0.079	0.917	1.154	0.047	0.059	0.019	0.700	1.000	0.350	0.094
DL-005-04B	1.019	1.122	0.150	0.870	0.972	0.075	0.059	0.031	0.709			0.075
DL-005	1.020	1.122	0.154	0.972	0.870	0.080	0.060	0.031	ODD			0.076
DL-138-04A	1.040	1.040	0.046	1.004	1.004	0.043	0.040		0.800	0.800	0.100	0.060
DL-138-05A	1.040	1.040	0.046	1.004	1.004	0.043	0.040		0.800	0.800	0.100	0.060
DL-138	1.040	1.040	0.046	1.004	1.004	0.043	0.040	0.020	0.800	0.800	0.100	0.060
DL-346-1	1.040	1.540	0.046	1.004	1.505	0.046	0.040	0.020	ODD		ODD	0.061
DL-905-02B	1.060	1.410	0.050	0.970	1.381	0.040	0.060	0.015	0.700	1.000	0.100	0.093
DL-905-01B	1.061	1.411	0.050	0.970	1.320	0.040	0.060	0.015	0.700	0.900	0.350	0.093
DL-556-04B	1.062	1.391	0.083	0.997	1.318	0.062	0.040	0.020	0.900	1.000		0.056
DL-556	1.064	1.393	0.093	0.989	1.318	0.062	0.040	0.020	0.800	1.000	0.100	0.080
DL-017-01B	1.065	1.065	0.052	0.965	0.965	0.030	0.060	0.015	0.800	0.800	0.200	0.070
DL-017-05B	1.065	1.065	0.052	0.965	0.965	0.030	0.060	0.015	0.800	0.800	0.200	0.070
DL-017-06B	1.065	1.065	0.052	0.965	0.965	0.030	0.060	0.015	0.800	0.800	0.200	0.070
DL-030-01B	1.065	1.065	0.050	0.965	0.965	0.030	0.060	0.047	0.800	0.800	0.200	0.070
DL-187	1.090	1.525	0.046	1.040	1.475	0.046	0.040	0.015	0.900	1.350	0.100	0.042
DL-450-05A	1.100	1.100	0.125	1.000	1.000	0.090	0.060	0.015	0.800	0.800	0.100	0.056
DL-450-02A	1.100	1.100	0.125	1.000	1.000	0.090	0.060	0.015	0.800	0.800	0.100	0.056
DL-450	1.100	1.100	0.125	1.000	1.000	0.090	0.060	0.015	0.800	0.800	0.100	0.056
DL-190-07B	1.100	2.550	0.160	1.000	2.110	0.050	0.050		0.800	1.600	0.400	1230.000
DL-190-01B	1.100	2.870	0.160	1.006	2.016	0.050	0.050	0.050	0.800	1.600	N/A	0.124
DL-190-02B	1.100	2.870	0.160	1.006	2.006	0.050	0.050	0.050	0.800	1.600	0.400	0.124
DL-190-03B	1.100	2.870	0.160	1.006	2.016	0.050	0.050	0.050	0.800	1.600	N/A	0.124
DL-190-04B	1.100	2.870	0.160	1.006	2.016	0.050	0.050	0.050	0.800	1.600	N/A	0.124
DL-190-05B	1.100	2.870	0.160	1.006	2.016	0.050	0.050	0.050	0.800	1.600	N/A	0.124
DL-140-07B	1.107	2.005	0.092	0.960	2.016	0.042	0.060		0.800	1.600	0.400	0.123
DL-140-10B	1.107	2.005	0.092	0.960	1.960	0.042	0.060		0.800	1.600		0.123
DL-140-11B	1.107	2.005	0.092	0.960	1.960	0.042	0.060		0.800	1.600	0.400	0.123

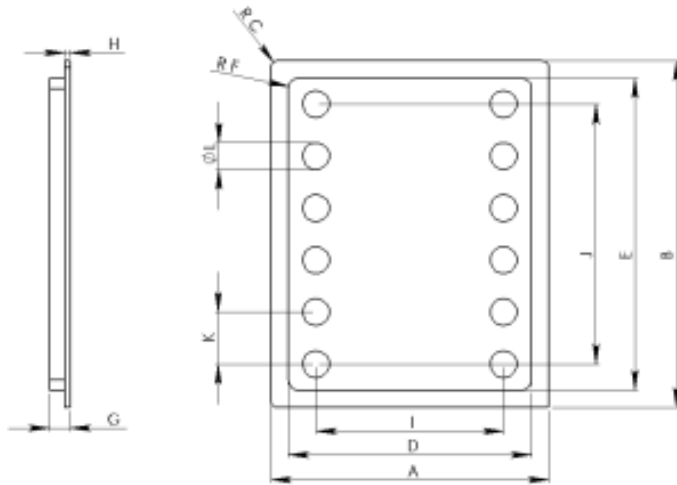

400 Kuller Road  
 Clifton, NJ 07011  
 Phone: 973.253.0500  
 Fax: 973.253.9611  
 Web: www.coining.com  
 E-mail: sales@coining.com

## DL • Dual In-Line Platforms • Coined Headers

	A	B	C	D	E	F	G	H	I	J	K	L
CTI Part#	Overall Width	Overall Length	OD Radius	Body Width	Body Length	Body Radius	OAH	Flange Thickness	Hole Grid Width	Hole Grid Length	Hole Pitch	Hole Dia
DL-140-13B	1.107	2.005	0.092	0.960	1.960	0.042	0.060		0.800	1.600	0.400	0.123
DL-140-07B	1.110	2.550	0.092	1.026	1.960	0.042	0.060		0.800	1.600	0.400	0.123
DL-140-08B	1.115	2.550	0.092	1.015	2.010	0.042	0.067		0.800	1.600	0.200	0.091
DL-140-01B	1.115	2.890	0.170	1.015	2.010	0.042	0.067	0.037	0.800	1.600	0.200	0.091
DL-197-01B	1.116	1.673	0.100			N/A	0.050		0.958	1.103	0.200	0.104
DL-135-33B	1.120	1.120	0.060				0.060		0.800	1.245	0.200	0.042
DL-711	1.120	1.360	0.080	1.020	1.260	0.030	0.060	0.015	0.900	1.100	0.100	0.056
DL-135-01B	1.120	1.450	0.050	1.015	1.345	0.035	0.060	N/A	0.800	1.000		0.080
DL-135-02B	1.120	1.450	0.050	1.015	1.345	0.035	0.060	N/A	0.800	1.000		0.080
DL-135-04B	1.120	1.450	0.050	1.015	1.345	0.035	0.060	0.015	0.800	0.900	0.200	0.080
DL-135-07B	1.120	1.450	0.050	1.015	1.345	0.035	0.060	0.015	0.800	1.000	0.400	0.080
DL-135-09B	1.120	1.450	0.050	1.001	1.341	0.035	0.067	0.015	0.800	0.900	0.200	0.067
DL-135-11B	1.120	1.450	0.050	1.015	1.345	0.035	0.060	0.015	0.900	0.960	0.200	0.080
DL-135-12B	1.120	1.450	0.050	1.011	1.341	0.035	0.067	0.047	0.800	0.900	0.200	0.080
DL-135-13B	1.120	1.450	0.050	1.011	1.341	0.035	0.067	0.047	0.800	1.000		0.080
DL-135-14B	1.120	1.450	0.050	1.015	1.345	0.035	0.053	0.015	0.900	1.000		0.080
DL-135-15B	1.120	1.450	0.050	1.015	1.345	0.035	0.060	0.015	0.800	0.900	0.100	0.080
DL-135-16B	1.120	1.450	0.050	1.015	1.345	0.035	0.060	N/A	0.800	1.000		0.080
DL-135-18B	1.120	1.450	0.050	1.011	1.341	0.035	0.067	0.047	0.800	0.800	0.200	0.080
DL-135-19B	1.120	1.450	0.054	1.015	1.345	0.039	0.063	0.015	0.960	1.105	0.200	0.081
DL-135-A	1.120	1.450	0.050	1.015	1.345	0.035	0.060	0.015	0.800	1.000	0.100	0.080
DL-135-B	1.120	1.450	0.020				0.060		0.800	0.900		
DL-135-30B	1.120	1.730	0.050	1.011		0.035	0.067	0.015	0.800	1.245	0.300	0.080
DL-135-23B	1.120	1.990	0.050	1.011	1.341	0.035	0.067	0.006	0.800	0.900	0.200	0.080
DL-135-C	1.120	1.990	0.050	1.011	1.341	0.035	0.060	0.015	0.800	1.000		
DL-135-20B	1.120	2.000	0.050	1.011	1.341	0.035	0.067	0.006	0.800	1.000	0.400	0.080
DL-137	1.120	2.110	0.091	1.020	2.010	0.042	0.060	0.030	0.800	1.600	0.200	0.091
DL-137-04B	1.120	2.110	0.091	1.020	2.010	0.042	0.067	N/A	0.800	1.600	0.200	0.091
DL-137-09B	1.120	2.110	0.091	1.020	2.010	0.042	0.067	N/A	0.800	1.600	0.200	0.091
DL-137-13B	1.120	2.110	0.091	1.020	2.010	0.042	0.067		0.800	1.600	0.200	0.091

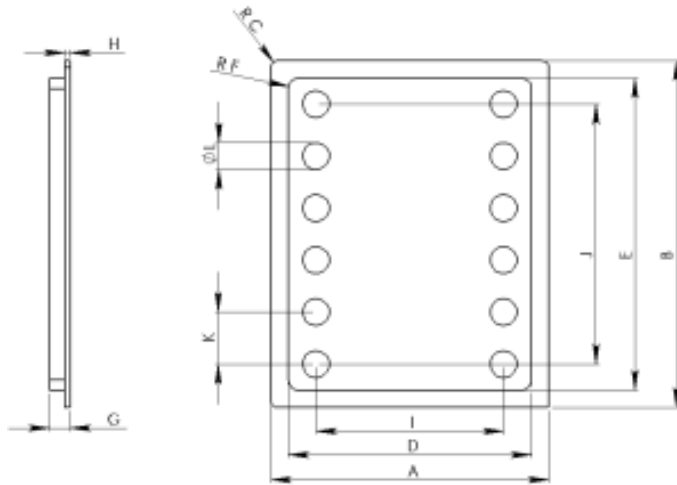

400 Kuller Road  
 Clifton, NJ 07011  
 Phone: 973.253.0500  
 Fax: 973.253.9611  
 Web: www.coining.com  
 E-mail: sales@coining.com

## DL • Dual In-Line Platforms • Coined Headers

	A	B	C	D	E	F	G	H	I	J	K	L
CTI Part#	Overall Width	Overall Length	OD Radius	Body Width	Body Length	Body Radius	OAH	Flange Thickness	Hole Grid Width	Hole Grid Length	Hole Pitch	Hole Dia
DL-327-05A	1.122	1.740	0.156	1.039	1.640	0.104	0.059	0.015	0.900	1.400	0.100	0.055
DL-401	1.139	1.239	0.155	1.039	1.139	0.105	0.040	0.015	0.900	0.900	0.100	0.056
DL-327	1.139	1.739	0.155	1.039	1.639	0.105	0.040	0.015	0.900	1.400	0.100	0.056
DL-401-01A	1.140	1.240	0.155	1.040	1.140	0.105	0.060	0.015	0.900	0.900	0.100	0.056
DL-401-02A	1.140	1.240	0.155	1.040	1.140	0.105	0.060	0.015	0.900	0.900	0.100	0.056
DL-401-06A	1.140	1.240	0.155	1.040	1.140	0.105	0.060	0.015	0.900	0.900	0.100	0.056
DL-358	1.140	1.739	0.155	1.040	1.639	0.105	0.040	0.015	0.900	1.500	0.100	0.056
DL-358-02A	1.140	1.739	0.155	1.040	1.639	0.105	0.060	0.015	0.900	1.500	0.100	0.056
DL-358-05G	1.140	1.739	0.155	1.040	1.639	0.103	0.060	0.015	0.900	1.500	0.100	0.056
DL-327-04G	1.140	1.740	0.155	1.040	1.639	0.105	0.060	0.015	0.900	1.400	0.100	0.056
DL-327-15G	1.140	1.740	0.155	1.040	1.639	0.105	0.060	0.015	0.900	1.200	0.100	0.056
DL-358-10A	1.140	1.740	0.155	1.040	1.640	0.105	0.060	0.015	0.900	1.200	0.056	0.056
DL-526-02A	1.179	1.179	0.060	1.099	1.099	0.019	0.023		0.800	0.800	0.050	0.021
DL-831	1.220	1.299	0.080	1.120	1.199	0.035	0.060	0.015	1.000	1.100	0.100	0.056
DL-029-01A	1.240	1.240		1.135	1.135		0.061		0.956	0.956		0.054
DL-029-01G	1.244	1.244	0.118	1.134	1.134	0.078	0.059	0.015	0.897	0.956	0.050	0.055
DL-029-01B	1.244	1.244	0.118	1.134	1.134	0.078	0.059	0.015	0.897	0.956	0.050	0.055
DL-165-01A	1.248	1.248	0.046	1.213	1.213		0.040	0.015	1.100	1.100	0.100	0.042
DL-165	1.248	1.248	0.046	1.213	1.213	0.046	0.040	0.015	1.100	1.100	0.100	0.042
DL-271-01A	1.270	1.270	0.050	1.185	1.185	0.052	0.060	0.015	1.100	1.100	0.100	0.056
DL-505-01A	1.270	1.270	0.050	1.185	1.185		0.060	0.015	1.100	1.100	0.100	0.056
DL-505-06A	1.270	1.270	0.050	1.185	1.185	0.052	0.060	0.015	1.100	1.100	0.100	0.056
DL-271	1.270	1.270	0.050	1.185	1.185	0.052	0.060	0.015	1.100	1.100	0.100	0.056
DL-505	1.270	1.270	0.050	1.185	1.185	0.040	0.060	0.015	1.100	1.100	0.100	0.056
DL-593	1.280	1.280	0.046	1.185	1.185	0.046	0.040	0.015	1.100	1.100	0.100	0.042
DL-715	1.295	1.295	0.079	1.195	1.195	0.031	0.060	0.015	1.100	1.100	0.100	0.056
DL-016	1.298	1.798	0.046	1.264	1.764	0.046	0.040	0.016	1.100	1.600	0.100	0.056
DL-436	1.315	1.315	0.097	1.213	1.213	0.046	0.040	0.015	1.100	1.100	0.100	0.042
DL-626	1.329	1.830	0.046	1.262	1.763	0.046	0.040	0.015	1.100	1.600	0.100	0.056
DL-023	1.335	2.680	0.160	1.237	1.836	0.050	0.050	0.030	1.000	1.600	0.200	0.123

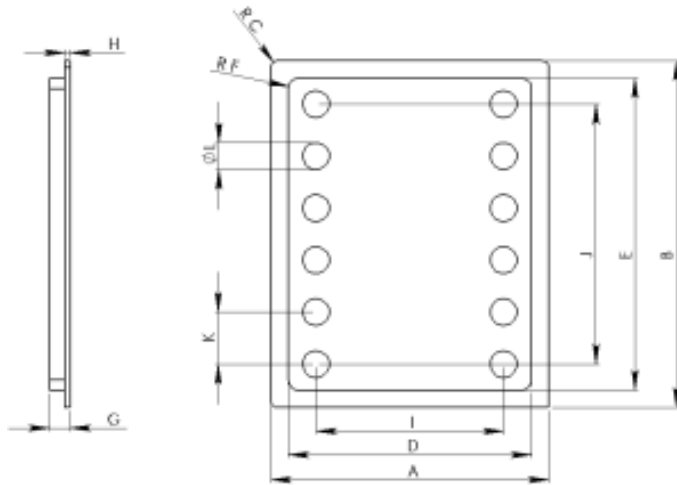

**400 Kuller Road**  
**Clifton, NJ 07011**  
**Phone: 973.253.0500**  
**Fax: 973.253.9611**  
**Web: www.coining.com**  
**E-mail: sales@coining.com**

## DL • Dual In-Line Platforms • Coined Headers

	A	B	C	D	E	F	G	H	I	J	K	L
CTI Part#	Overall Width	Overall Length	OD Radius	Body Width	Body Length	Body Radius	OAH	Flange Thickness	Hole Grid Width	Hole Grid Length	Hole Pitch	Hole Dia
DL-023-01B	1.335	2.680	0.160	1.237	1.836	0.050	0.050		1.000	1.600	0.200	0.124
DL-142-21B	1.337	1.937	0.020	1.253	1.854	0.025	0.060		1.000	1.600	0.400	0.042
DL-142-22B	1.337	2.700	0.020	1.200	1.800	0.025	0.060		1.000	1.600	0.400	0.123
DL-142-20B	1.340	1.940	0.070	1.255	1.855	0.025	0.060	0.030	1.000	1.600	0.400	0.123
DL-806-08A	1.340	1.940	0.155	1.240	1.840	0.105	0.060	0.015	0.900	1.600	0.100	0.015
DL-806-A	1.340	1.940	0.155	1.240	1.840	0.105	0.060	0.015	1.050	1.600	0.100	0.056
DL-806-B	1.340	1.940	0.155	1.240	1.840	0.105	0.060	0.015	1.100	1.600	0.100	0.056
DL-142-01B	1.340	2.700	0.170	1.255	1.855	0.025	0.060	0.030	1.000	1.600	0.400	0.123
DL-142-03B	1.340	2.700	0.170	1.255	1.855	0.025	0.060	0.030	1.000	1.500	0.400	0.123
DL-379	1.345	1.745	0.046	1.230	1.630	0.046	0.040	0.015	1.100	1.500	0.100	0.042
DL-141-03B	1.345	2.360	0.170	1.245	1.840	0.060	0.067	N/A	1.000	1.600	0.200	0.091
DL-141-04B	1.345	2.360	0.113	1.245	1.840	0.060	0.067		1.000	1.600	0.200	0.091
DL-141-01B	1.345	2.700	0.170	1.245	1.840	0.060	0.067	0.037	1.000	1.600	0.200	0.091
DL-761-12A	1.400	2.300	0.090	1.320	2.220	0.062	0.060		1.100	2.000	0.100	0.056
DL-761-A	1.400	2.300	0.095	1.320	2.220	0.065	0.060	0.022	1.140	2.055	.125*	0.081
DL-761-B	1.400	2.300	0.095	1.320	2.220	0.065	0.060	0.022	1.100	2.000	0.100	0.056
DL-007-03G	1.502	2.602	0.080	1.400	2.500	0.035	0.059	0.015	1.300	2.400	0.100	0.056
DL-295	1.595	1.595	0.090	1.460	1.460	0.060	0.040	0.022	ODD		0.100	0.056
DL-053	1.600	2.240	0.060	1.490	2.130	0.030	0.050	0.010	ODD		ODD	0.200
DL-348	1.650	4.800	0.010						ODD		ODD	0.042
DL-025-01G	1.855	2.886	0.125				0.050		2.350	1.360	0.340	0.109
DL-026-016	1.930	1.930	0.195				0.050		1.600	1.600	0.100	0.069
DL-026-01B	1.930	1.930	0.195				0.050		1.600	1.600	0.100	0.069
DL-531	1.990	2.990	0.065	1.910	2.910	0.035	0.015	0.006				
DL-028-01B	2.300	2.400	0.039	2.157	2.260	0.125	0.079	0.012	N/A		N/A	N/A
DL-935	2.450	3.600	0.010						2.200	2.850	0.100	0.056